

MANSOUR MOTI

Designer Of 3D Paper Models
& Graphic Designer

PORTFOLIO



CONTENTS



Part I (ABOUT ME)

Biography	4
Resume	5



Part II (PROJECTS)

Canadian automotive museum	10
Z-Art (Pakistan)	12
Midland Co. (Australia)	18
Ofoq Publishing	20
Phoenix Series	38
Iran Khodro Diesel Co.(IKD)	54
Miscellaneous Projects	60



Part III (Exhibitions, Certificates, . . .)

EXhibitions	66
Certificates	68
Memberships	70
Interviews	72
Letters Of Appreciation	73



Mansour Moti Portfolio





Part I (ABOUT ME)

Biography

Resume

Biograph

Mansour Moti Portfolio

Biography



Mansour Moti was born on September 19th, 1971 in Bojnourd, Iran. He is one of the few designers of 3D paper models in Iran whose interest in art can be traced back to his childhood. After familiarity with the 3D paper model at a young age, Mansour Moti moved towards self-taught skills in designing 3D paper models and replica making. With more than 20 years of professional 3D paper model design and graphic design experience, he has been a freelance artist, specialized in 3D paper model design in both instructional-entertainment and advertising areas, particularly books for all ages and industrial products' promotions. He is known for his ten published books of scale 3D paper models of cars, airplanes, commercial vehicles, etc. by Ofoq publishing. In addition, some domestic and international projects of 3D paper models are his recent achievements, included in this portfolio.

His areas of expertise include 3D paper model design, replica and model design and making, graphic design by softwares such as Adobe Photoshop, Adobe Indesign, 3D Studio Max, Corel Draw and Pepakura Designer.

Resume

PROFESSIONAL EXPERIENCE

SELF EMPLOYED (MANSOUR MOTI PERSONAL BRAND), TEHRAN, IRAN

Designer of 3D Paper Models, Graphic Designer and Instructor, 08.2015 – Present

- Design three-dimensional paper models of four super cars for Z-art project (SHAFI-ULLA ZAR), Pakistan
- Design trailers as 3D paper model for Midland Company, Australia

OFOQ PUBLISHING INSTITUTE, TEHRAN, IRAN

Designer of 3D Paper Models, Graphic Designer and Author, 01.2006 – Present

- Designing and Making 5 Scale 3D paper model books from Old Automobiles (Classic) Series: Pikan Javanan (Chrysler Hunter), Renault 5, Buick Electra, Dodge Charger, Ford Thunderbird.(In the production stage)
- Designing and Making 5 Scale 3D paper model books from House Construction Series: Villa House 1/ Villa House 2/ Modern House 1/ Modern House 2/ Apartment.(In the production stage)
- Designing the book Series titled "My Handiworks (Kardastiyeh Man)"
- Designing and Making 5 Scale 3D paper model books from Dinosaur Series: Brachiosaurus, Stegosaurus, Triceratops, Pterodactyl and Tyrannosaurus .(In the production stage)
- Designing and Making 5 Scale 3D paper model books from Road Construction Vehicles Series: Loader, Bulldozer, Grader, Excavator and Rollers.

IRAN KHODRO DIESEL COMPANY, TEHRAN, IRAN

Designer of 3D Paper Models, Designer and Advertiser, 06.1998 – Present

- Design, Make 3D Paper Model (Printing and packaging) of (Foton AUMAN EST A) Tractor Head
- Design, Make and Print the 3D Paper Model of Mercedes Benz Actros Tractor Head
- Design, Make and Print the 3D Paper Models of Iran Khodro Diesel Company's Products
- Design, Make and Print the 3D Paper models (collection) Booklet of Products Manufactured by Iran Khodro Diesel Company
- Design, Make and Print the 3D Paper Model of Faraz(Howo) Tractor Head
- Design, Make and Print the 3D Paper Model of SC 457 intercity bus
- Design, Make and Print the 3D Paper Model of Neoplan Sky liner bus

PETRO FIDAR PALAYESH COMPANY, TEHRAN, IRAN

Graphic Designer, 09.2020 – 10.2020

- Domestic and foreign packaging design for the advertisement gifts

NAMASAAZ MAGAZINE, TEHRAN, IRAN

Founder, Graphic Designer and Designer of 3D Paper Models, 09.2016 – 11.2018

NASL-E-BARTAR MAGAZINE, TEHRAN, IRAN

Designer of 3D Paper Models and Graphic Designer, 09.2016 – 06.2017

- Design 3D paper Model of Client Intended Vehicles

IRAN MAKET INSTITUTE, TEHRAN, IRAN

Designer of 3D Paper Models and Graphic Designer, 02.2016 – 10.2017

- Design 3D paper Model of Airplanes and Helicopters

TAFAKOR VA SANAAT PARSIAN ENGINEERING COMPANY, TEHRAN, IRAN

Graphic Designer, 10.2015 – 02.2017

- Design and produce four 3D paper models (Sedan-Autobus-Airplane-House)
- Design and produce two 3D paper Models of instructional package

CHIKA NICK TEJARAT COMPANY (HYPER TIRE), TEHRAN, IRAN

Graphic Designer, 04.2018 – 05.2018

- Design and make 3D paper models as representation of the second generation of rescue cars manufactured by Hyper Tire Company.

CHIKA NICK KHODRO COMPANY, RASHT, GILAN, IRAN

Designer of 3D Paper Models, 07.2016 – 09.2015

- Design 3D paper Models of four cars imported by this company.

KELK 80 ARTISTIC AND CULTURAL INSTITUTE, TEHRAN, IRAN

Manager of Designing Atelier and Deputy of the Institute, 05.2013 – 04.2019

Resume

FARZANEGAN TAKAPOU FACTORIES COMPANY, KARAJ, ALBORZ, IRAN

Graphic Designer, 12.2017 – 12.2018

- Design Creative Food Packaging for Products

SHEIKH MOHAMMAD KHIABANI SCHOOL, TEHRAN, IRAN

Designer of 3D Paper Models, 10.2018 – 11.2018

- Selling 184 copies of four topics of 3d Paper Models

RAJA PASSENGERS TRAVELLING CO., TEHRAN, IRAN

Designer of 3D Paper Models, 07.2004 – 08.2004

- Design and execute 3D paper model of train

KHANE VA KHANEVADEH MAGAZINE, TEHRAN, IRAN

Graphic Designer, 04.1997 – 05.1998

DOKHTARAN VA PESARAN MAGAZINE, TEHRAN, IRAN

Technical and Artistic Management, 05.1996 – 07.1997

SHAHRE SHAB PAINTING GALLERY, MASHHAD, RAZAVI KHORASAN, IRAN

3D Paper Modeler, 08.1993 - 02.1995

PARTICIPATION

HOLDING "3D PAPER MODELS EXHIBITION" UNDER THE TITLE OF "MY PAPER WORLD (DONYAYE KAGHAZI MAN)", TEHRAN, IARN

Held at Abi Art Gallery in Omid Cultural Centre, 09.2018 - 10.2018

PARTICIPATION IN "EXHIBITING THE BOOK COLLECTION" UNDER THE TITLE OF "MY HANDI-WORKS (KARDASTIYE MAN)", TEHRAN, IRAN

As a Designer of 3D Paper Models and Author, Held at International book fair, 10.2008 - 09.2022

HOLDING SOLO "3D PAPER MODELS" EXHIBITION, TEHRAN, IRAN

Held at Erick Art Gallery, 11.2015

and . . .

Education

IMAM REZA INTERNATIONAL UNIVERSITY, MASHHAD, RAZAVI KHORASAN, IRAN

Master of Art Economics, 09.2015 – 09.2017

UNIVERSITY OF APPLIED SCIENCE AND TECHNOLOGY-KHANEH KAREGAR, QAZVIN, IRAN

Bachelor of Graphics-Illustration, 02.2009 – 02.2011

TECHNICAL INSTITUTE OF ENGHELAB-E ESLAMI TECHNICAL HIGHER EDUCATION CENTER, TEHRAN, IRAN

Associate's of Technical Graphic Teaching, 02.1995 – 04.1998

SHAHID DASTGHEIB HIGH SCHOOL, MASHHAD, RAZAVI KHORASAN, IRAN

Diploma of Experimental Sciences, 09.1985 – 06.1990

Research Background

MASTER'S THESIS UNDER THE TITLE OF "STRATEGIC ANALYSIS OF THE FACTORS INFLUENCING THE MARKET OF 3D PAPER MODELS IN IRAN", MASHHAD, RAZAVI KHORASAN, IRAN

Imam Reza International University, 09.2017

FINAL PROJECT OF BACHELOR'S PROGRAM UNDER THE TITLE OF "THE PROCESS OF DESIGNING AND MAKING 3D PAPER MODELS", QAZVIN, IRAN

University of applied science and technology-khaneh karegar, 07.2010

Skills

Language Skills:

- English: Intermediate
- Persian: Native

Other Skills:

- Adobe Photoshop
- Corel Draw
- Adobe Illustrator
- 3D Studio Max
- Adobe InDesign
- Office



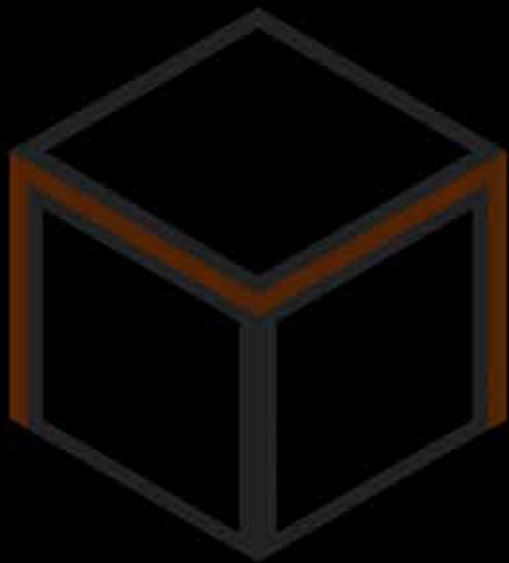

Part II (PROJECTS)

Canadian Automotive Museum(Canada)

Z - Art(Pakistan & United State)

Midlan(Australia)

Ofoq Publishing(Iran)

Phoenix series(Iran)

Iran Khodro Diesel Co.(Iran)

Canadian

Mansour Moti Portfolio

Concerning that natural history and automotive museums are one of my potential clients, I contacted some of them in Canada and US too. (our emails are enclosed in my sent documents).

Based on an agreement with Canadian Automotive Museum in Oshawa, as the first step toward our possible cooperation in the future, I proposed to make two of their cars' 3D paper models.



DeLorean dmc - 12



photo sent by the museum



3d paper model made by me

A automotive Museum

Canadian Automotive Museum / Spring 2022

1931 MCLAUGHLIN-BUICK 67 MODEL



photo sent by the museum



3d paper model made by me



Multiple parts of 1931 MCLAUGHLIN-BUICK model on 3 sheets in A4 size.

Z-ART

Mansour Moti Portfolio

The Z-Art project was a collaborative project of designing 3D paper models with Shafiullah Zar in Pakistan according to his client's order in the United States. In this project, I designed 4 models of famous cars as an accomplished contract and, in continue, several models will be done that two of them are completed and, the photos are included.

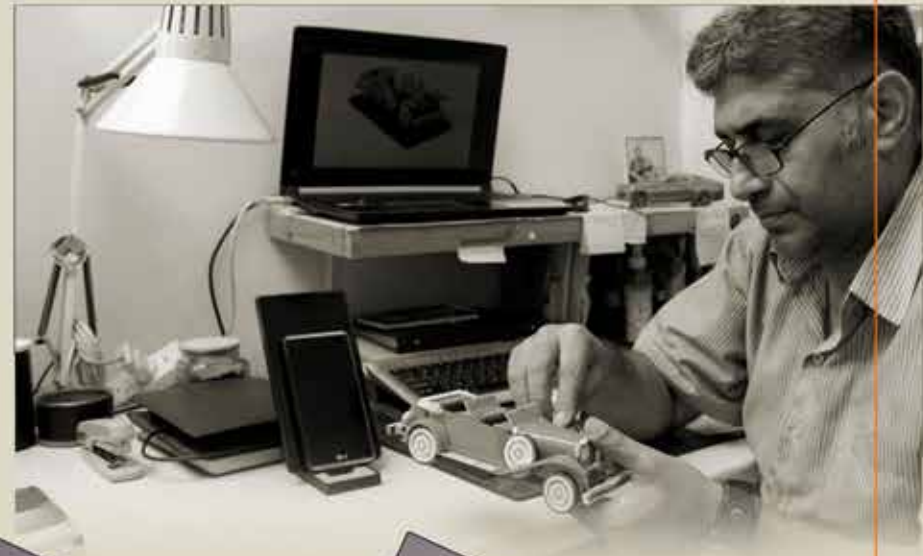

DUESENBERG

Z-ART / Winter 2021

I have been keen on designing an old classic car's 3D paper model for a long time and, fortunately, I achieved this goal through this project (Z-ART contract). This model consists of about 70 pieces, printed on five A4 sheets. I love this model.



Duesenberg 3D Paper model made by me.



Multiple parts of Duesenberg model on 5 sheets in A4 size.

LAMBORGHINI - HURACAN

PAPER MODEL

The **Lamborghini Huracan** was the sconed of four models and the most challenging.



Lamborghini Huracan 3d paper model made by me.



Multiple parts of Lamborghini Huracan model on 3 sheets in A4 size

Rolls-Roise

PAPER MODEL

Z - ART / Winter 2021

Rolls-Royce was another model of this project, which, despite its simple look, was really difficult to design and assemble.



Rolls-Royce 3d paper model made by me.



Multiple parts of Rolls-Royce model on 3 sheets in A4 size.

Aston-Martin

PAPER MODEL

The **Aston Martin** 3D paper model came to the result through 16 edits. The more edits means the more complexity of the model.



Aston-Martin 3d paper model made by me.

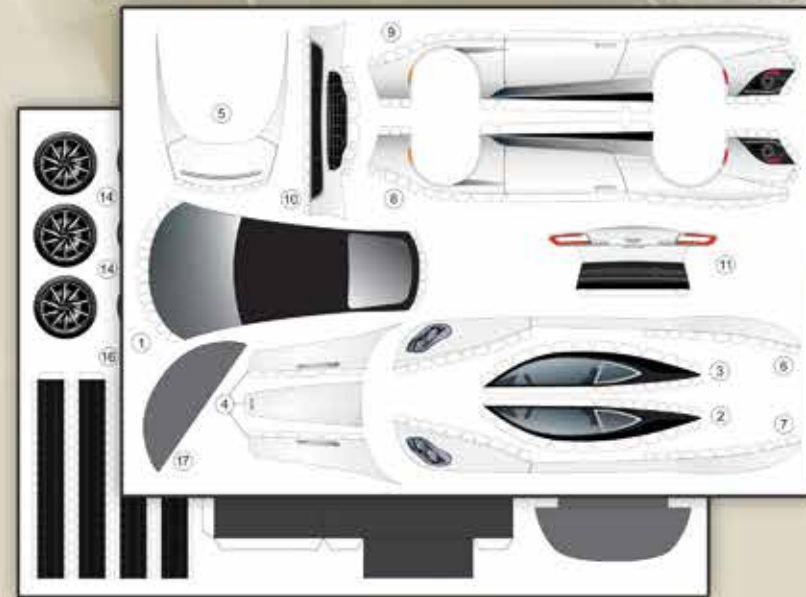

Multiple parts of Aston Martin model on 2 sheets in A4 size.

Z-ART PAPER MODELS

Z - ART / Winter 2021

Two mentioned models of the z-art project.

Cadillac escalade



Bugatti chiron pur sport



3d paper models made by me



Midland Pty Ltd is a %100 Australian-owned and fabricated, specialist truck trailer manufacturer. The managers of this company through visiting my site and being interested in my projects contacted me and ordered one of their products 3D paper model to be used for advertising purposes.

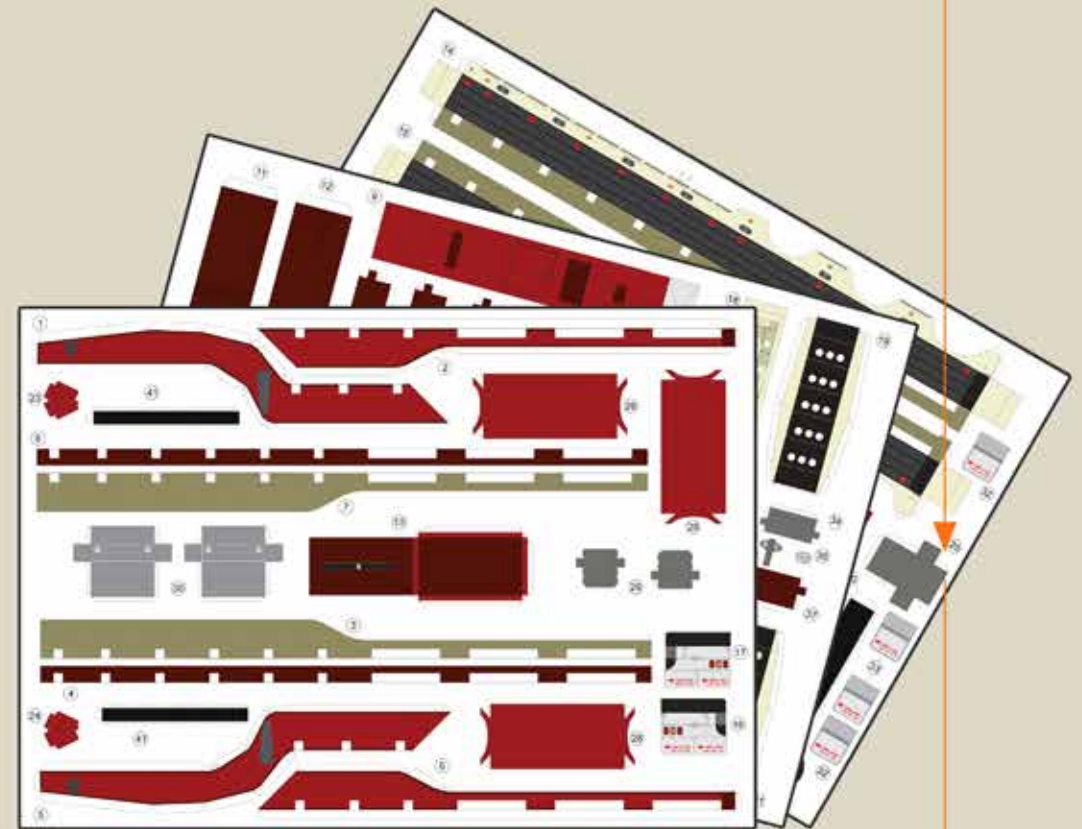

Multiple parts of Midland product model on 3 sheets in A3 size.

NLD

MIDLAND

PAPER MODEL

MIDLAND CO. / Winter 2021



3d paper model made by me

Ofoq Pub

Mansour Moti Portfolio

My collaboration with Ofoq publishing, one of the most well-known in Iran, started with two 3D paper model collections, titled "Kardastie Man" (My Handworks). Every collection consists of 5 books on various topics. The first collection is available in Vancouver_Canada in the Pan-Beh bookstore now. you can find them on the website:(www.Pan-Beh.com).



A branche of Ofoq bookstores in Tehran



"Kardastie Man" books (The first collection)

ROAD CONSTRUCTION VEHICLES

Ofoq Publishing / Summer 2017

The second collection of (Kardastye Man) books, namely (Road Construction Vehicles) have been published and on the market(second edition).



After the selection of the original sample and the determination of design level, it`s time to draw brief sketches as the base of different parts` designing.

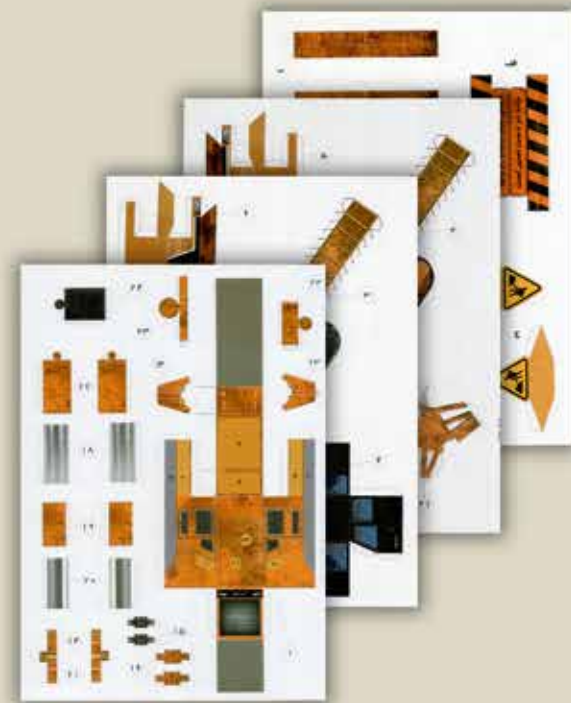
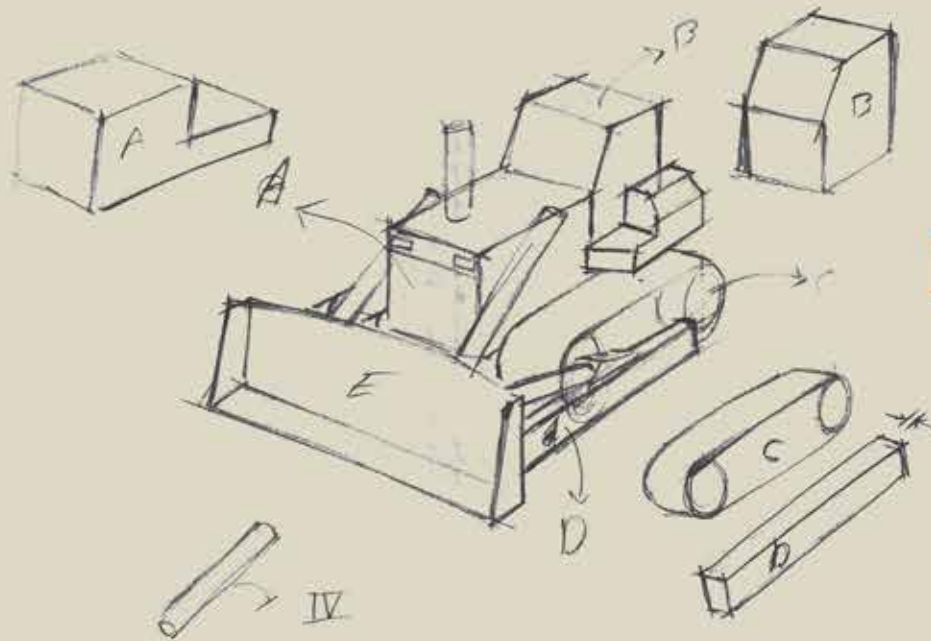

BULLDOZER

PAPER MODEL

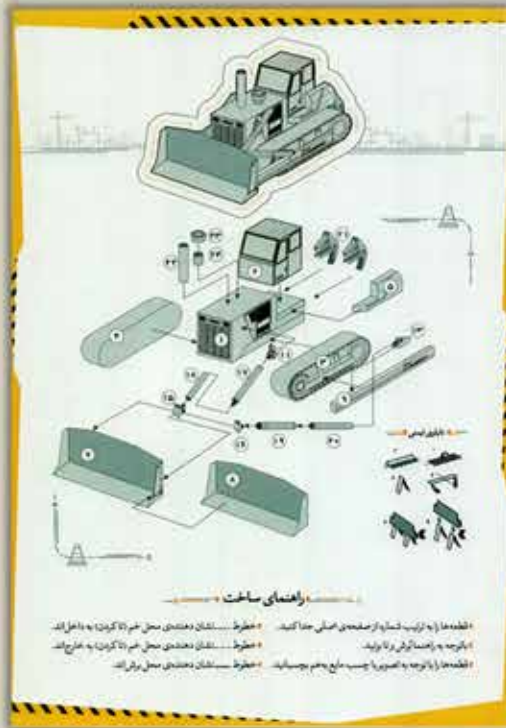

Instruction page

The completed model by following the Instructions.





Grader 3D paper model designed at the hard level, is one book of a collection namely, Road Construction Vehicles.

GRADER

PAPER MODEL



*In four A4 Size Pages
80 gr < Glossy paper < 200 gr
200.90.84 mm*





The Excavator model designed at the medium level.

EXCAVATOR

PAPER MODEL



*In four A4 Size Pages
80 gr < Glossy paper < 200 gr
210.88.130 mm*



UNDER CONSTRUCTION



The Loader as the most popular in the mentioned collection designed at the medium level is so absorbing to the audiences.

LOADER

PAPER MODEL



*In four A4 Size Pages
80 gr < Glossy paper < 200 gr
229.89.89mm*





The Roller model designed at the easy level for young audiences.

ROLLER

PAPER MODEL



In four A4 Size Pages
80 gr < Glossy paper < 200 gr
170.70.85 mm



Ofoq Publishing

Published models consist of my first collection under the title of "Kardastye Man(My Handiworks). (Autumn 2007)



DINOSAURS

PAPER MODELS

The next, titled (My Paper Dinosaur) is still in process of publishing.

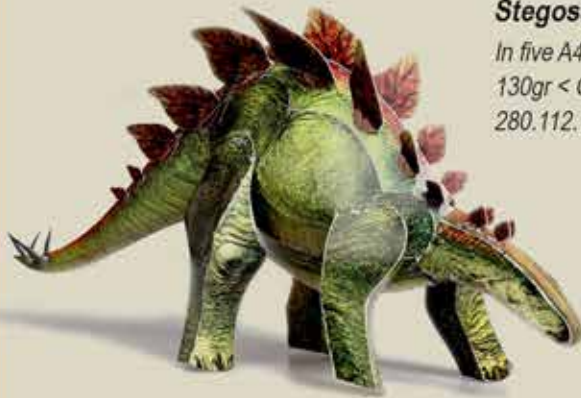

Stegosaurus

*In five A4 Size Pages
130gr < Glossy paper < 200 gr
280.112.125 mm*



Tyranosaurus- Rex

*In six A4 Size Pages
130gr < Glossy paper < 200 gr
193.390.95 mm*



Pterodactyl

*In four A4 Size Pages
130gr < Glossy paper < 200 gr
280.112.125 mm*

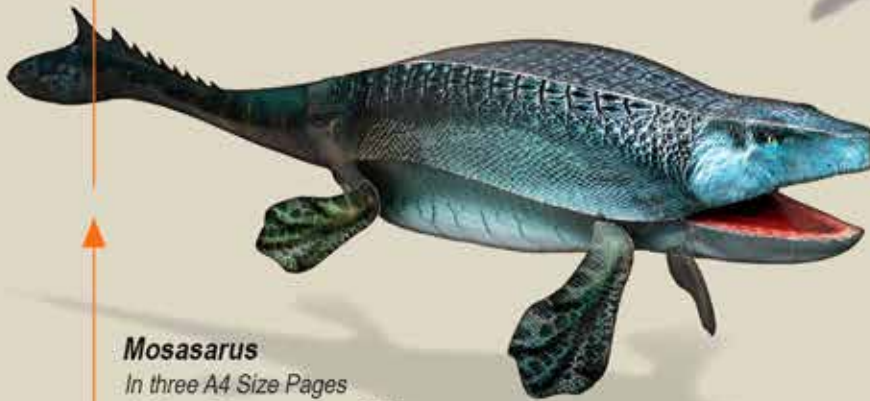

Mosasaurus

*In three A4 Size Pages
130gr < Glossy paper < 200 gr
280.112.125 mm*



Triceratops

*In six A4 Size Pages
130gr < Glossy paper < 200 gr
193.390.95 mm*

MOSASAURS

One of the most beautiful models in this collection is Mosasaurs, an aquatic dinosaur that has a special position in this collection. The length of this paper model from head to tail is about 40 cm. and its pieces are printed on three sheets of A4 cardboard.

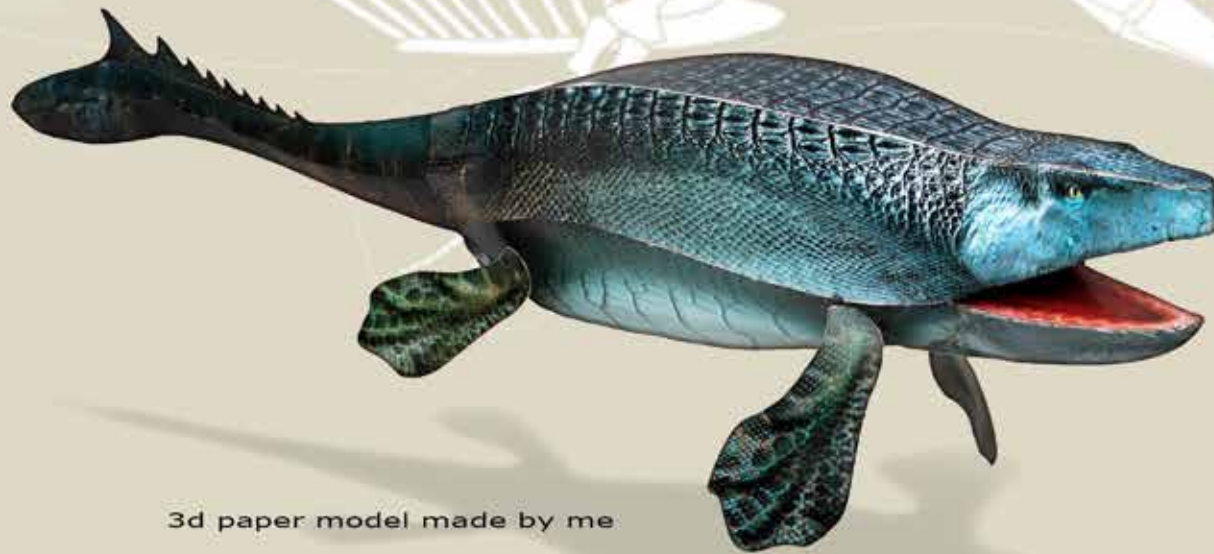

3d paper model made by me



DINOSAURS

PAPER MODELS

STEGOSAURUS

Stegosaurus is another dinosaur in this collection the length of its model from head to tail is about 35 cm. And, the pieces are printed on five sheets of A4 cardboard.

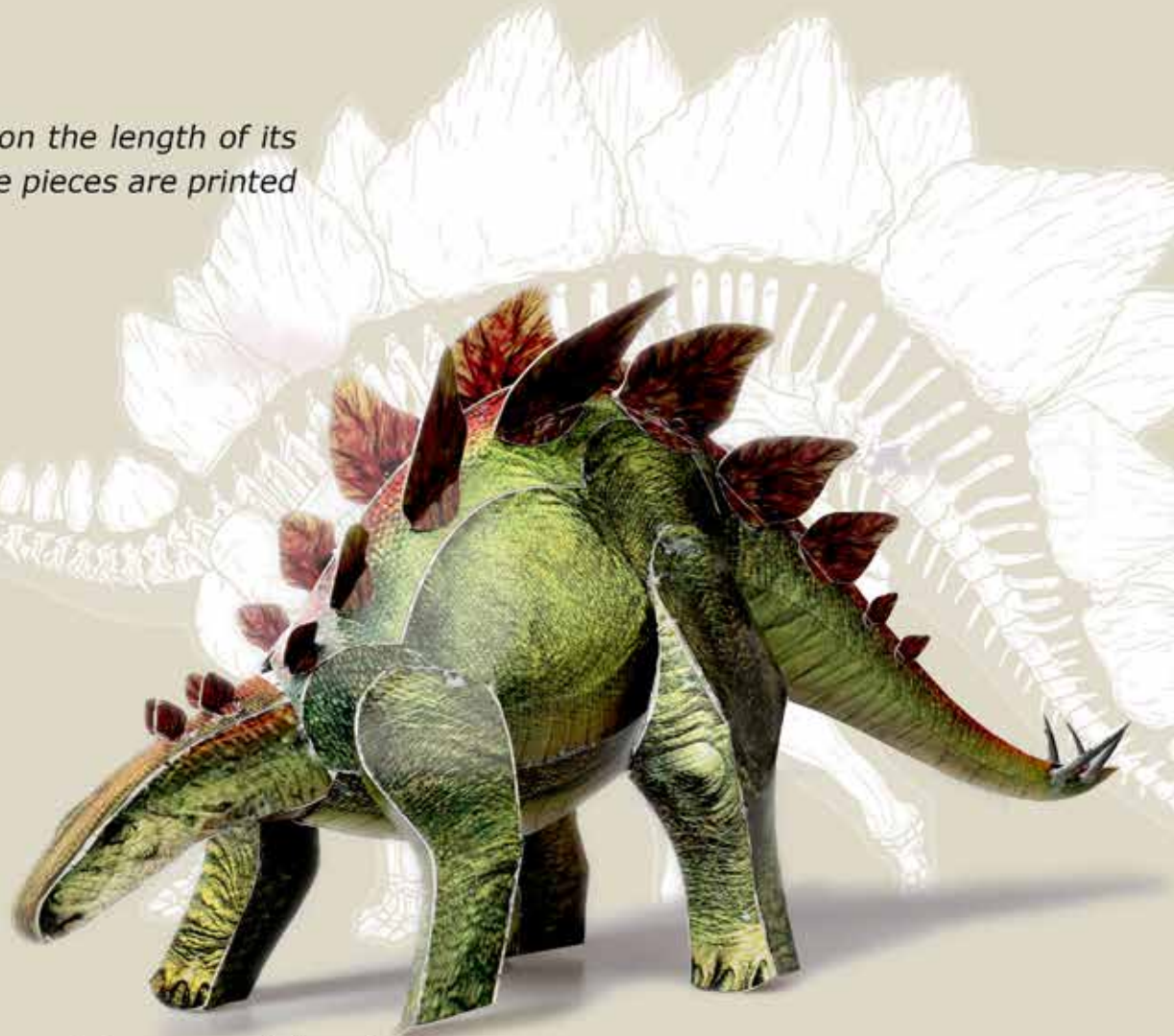

3d paper model made by me

Tyrannosaurus

Tyrannosaurus is the symbol of the Jurassic and Dinosaurs eras so it seemed to be necessary for me to involve its 3D model in the present collection, however, designing and assembling its pieces was definitely hard in terms of keeping the model balanced on two feet.

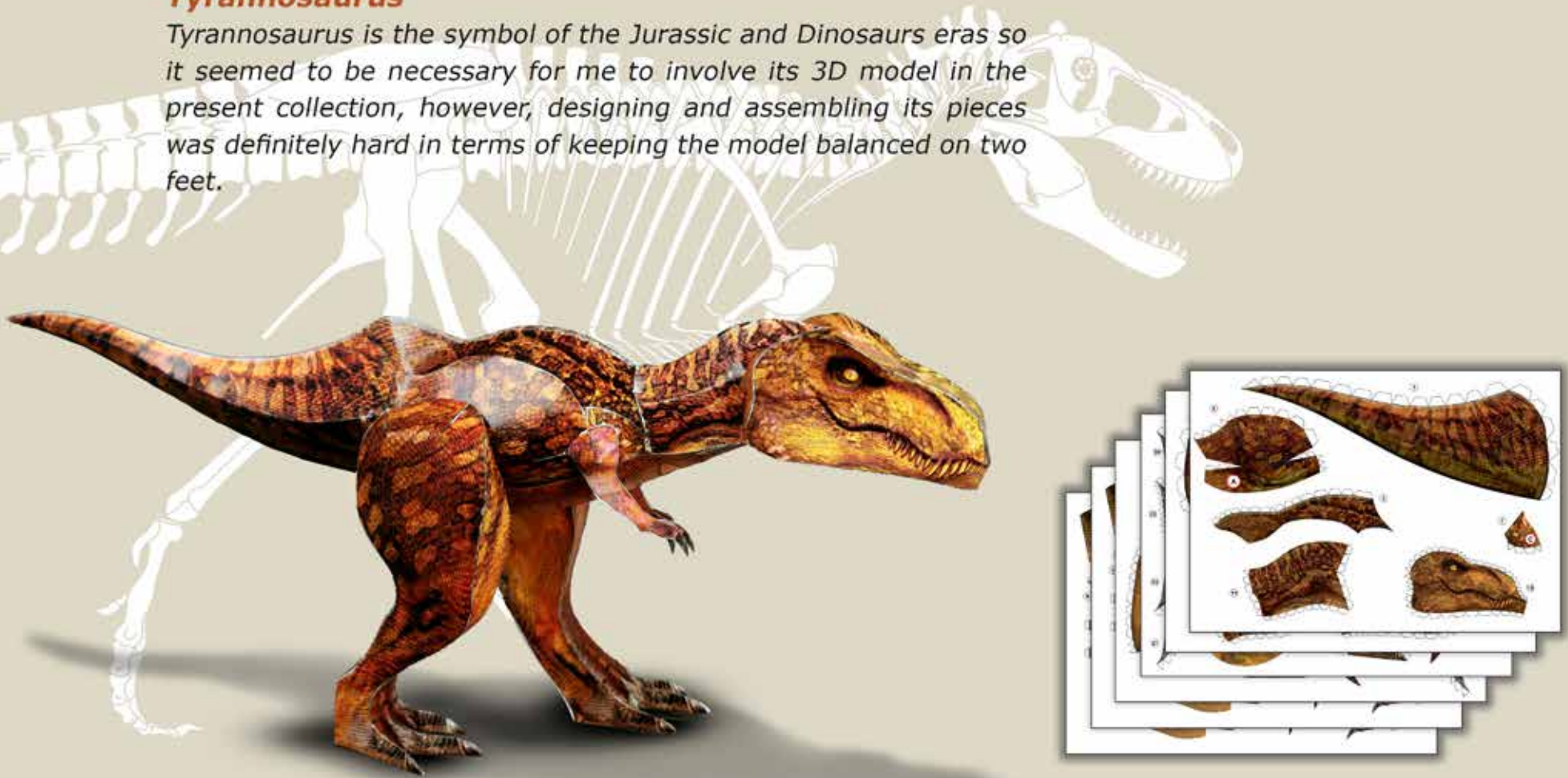

3d paper model made by me

DINOSAURS

PAPER MODELS

Triceratops

Triceratops is another Jurassic dinosaur that was always in conflict with Tyrannosaurus as his favorite food. Therefore, the design of the Triceratops model completed this collection. So I did it!

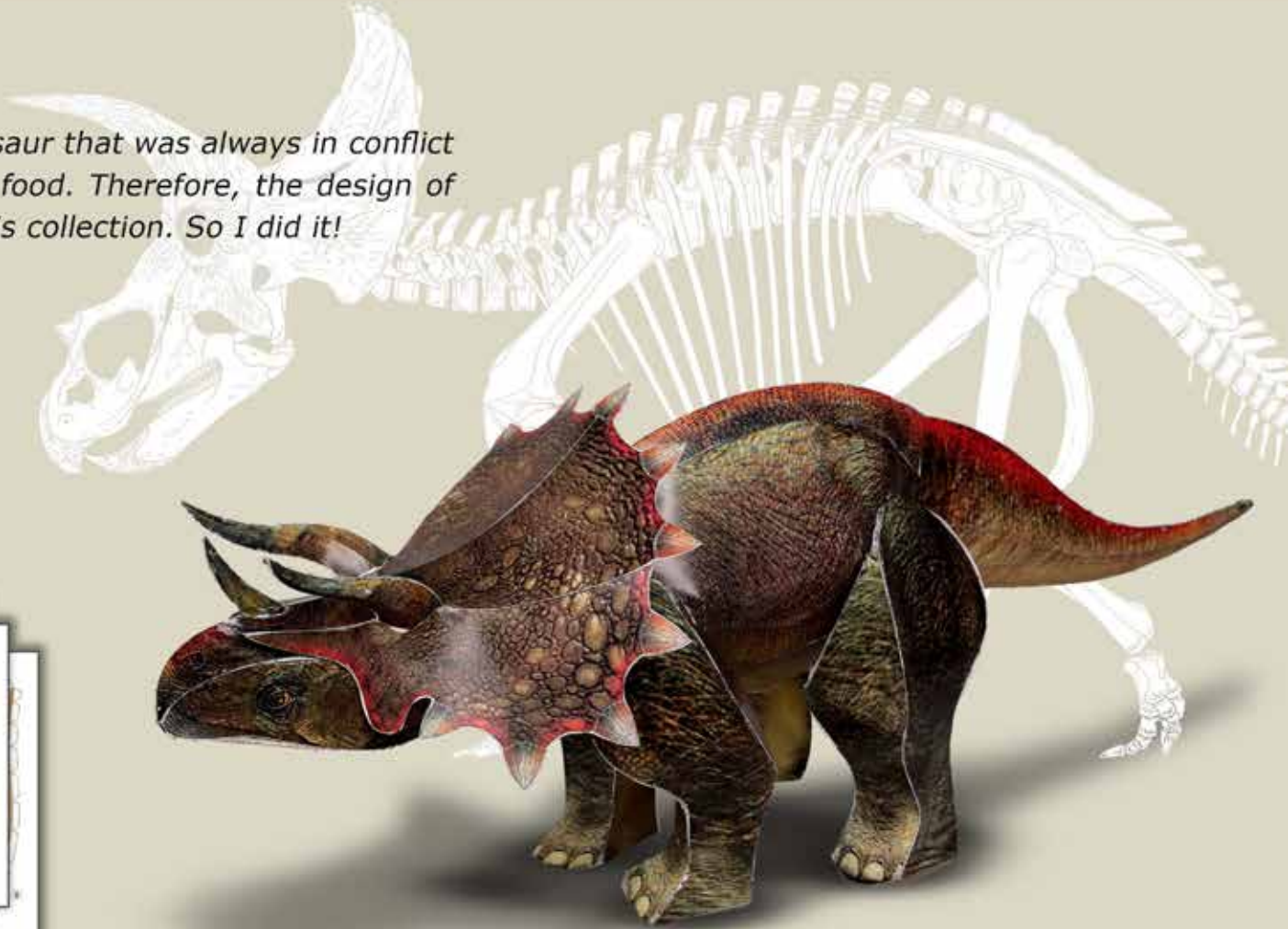

3d paper model made by me

Phoenix

Mansour Moti Portfolio

Phoenix series



PHOENIX

The Phoenix series, I can say, is my attempt to improve my ability to design variant types of models on different complexity levels for the purpose of proposing to the appropriate clients like kids' publishings and some related museums, ... Maybe it will happen in Canada.



Series



My own atelier in Tehran



Phantom / F-4

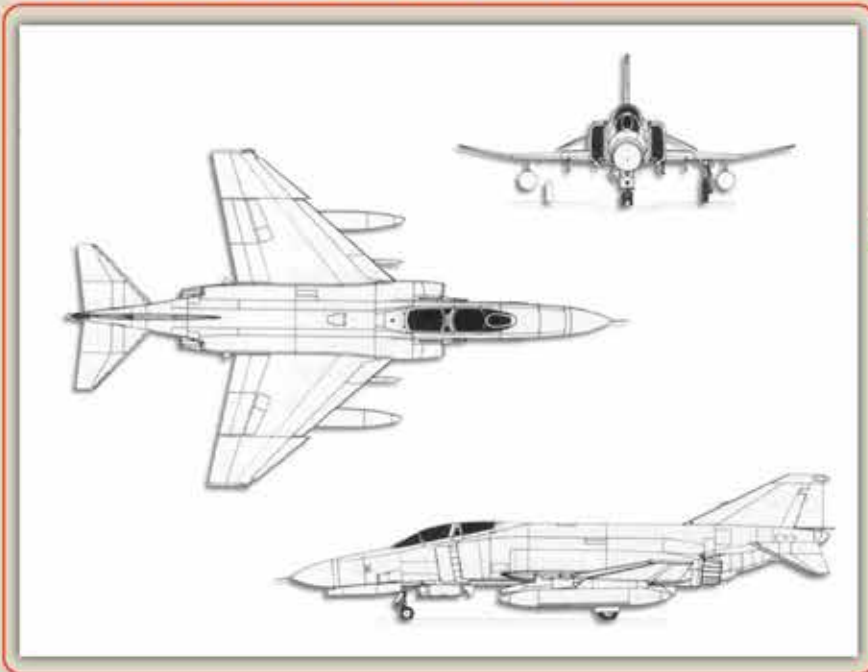

Phantom/ F - 4

Among the various models included in the mentioned collection, this model may be the most remarkable and interesting one as a result of designing tried to be similar to the original as much as possible, while it`s easy enough for the audiences to make.

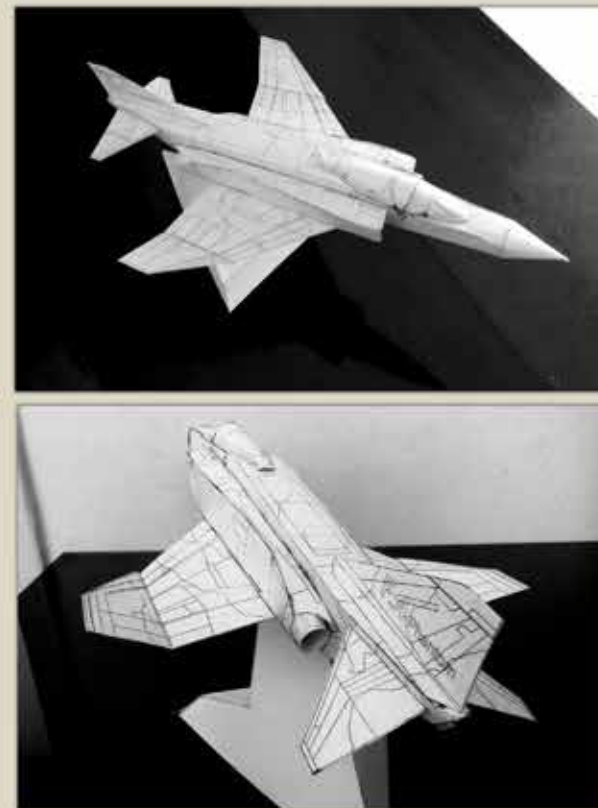

Primary colorless sample made by me

PHANTOM / F-4

PAPER MODEL



Completed model made by me

In four A4 Size Pages

80 gr < Glossy paper < 200 gr

283.55.185mm

Chevrolet Suburban

Chevrolet Suburban

Sport-utility vehicles(SUVs) 3D paper models can be one of the best for teenage and even older avid collectors of car models.

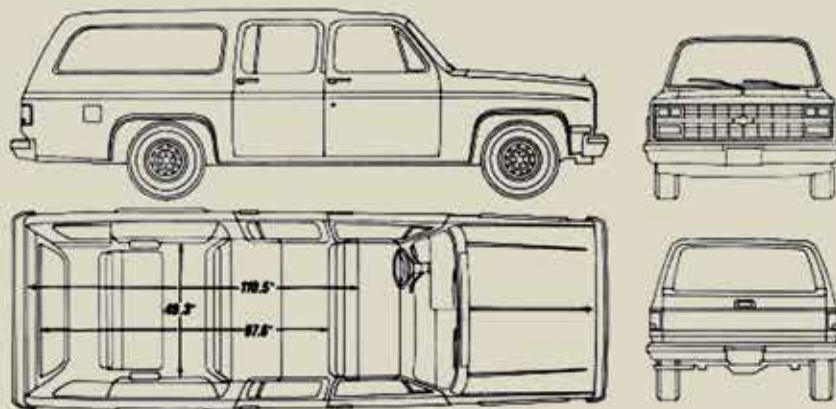

Making the test model helps me to find the mistakes in designing.

CHEVROLET SUBURBAN

PAPER MODEL



Completed model made by me

In four A4 Size Pages

80 gr < Glossy paper < 200 gr

207.75.75mm

CHRYSLER HUNTER



The original sample of the year, 1966–1979 (until 2005 in Iran)

A nostalgic model for grandparents

Why not? Retired people can be the target audience of such an old car 3D paper model to spend pleasant leisure time, besides young people keen on old and classic cars.

CHRYSLER HUNTER

PAPER MODEL



Completed model made by me

In four A4 Size Pages

80 gr < Glossy paper < 200 gr

233.122.135mm

Nice Villa

A nice model of villa

Maybe different sorts of houses are suitable 3d paper models to be chosen by all ages to make. You are looking at one of them designed with some changes to the original plan.



Choosing the original sample and considering the convertibility to a 3D paper model.



The initial sketch to find the number of parts.

NICE VILLA

PAPER MODEL



Completed model made by me

In four A4 Size Pages

80 gr < Glossy paper < 200 gr

285.200.95 mm

Modern Yacht

A model of Modern Yacht

Ships can highly be suitable for 3D paper models, designed at the almost hard level intended for a keen audience of adult age that Phoenix Series includes one of them.



Test model made by me

MODERN YACHT

PAPER MODEL



Completed model made by me

In four A4 Size Pages

80 gr < Glossy paper < 130 gr

220.90.43mm

TINY CARS

Tiny cars

Children are considered the principal audience for 3D paper models. They are interested in colorful and easy models to experience creativity besides a leisure time activity.



Samples made by children before the final design

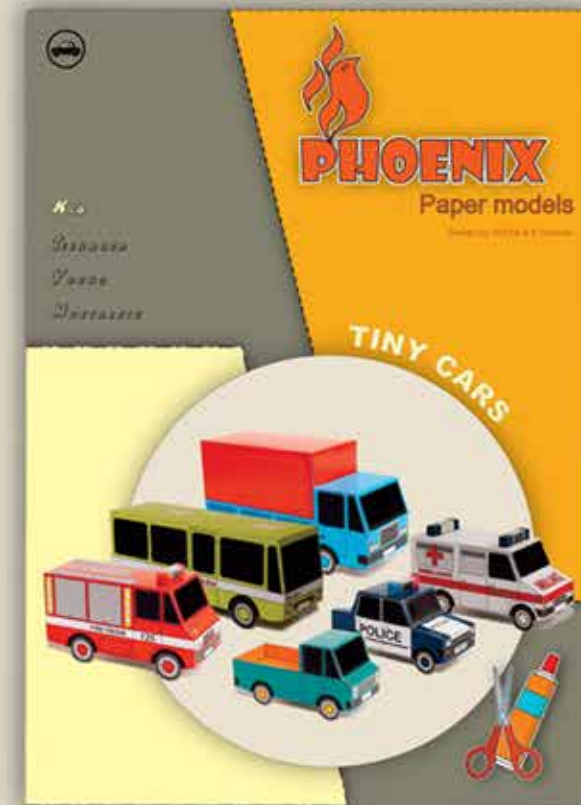

TINY CARS

PAPER MODEL



Completed models mad by me



TINY ANIMALS

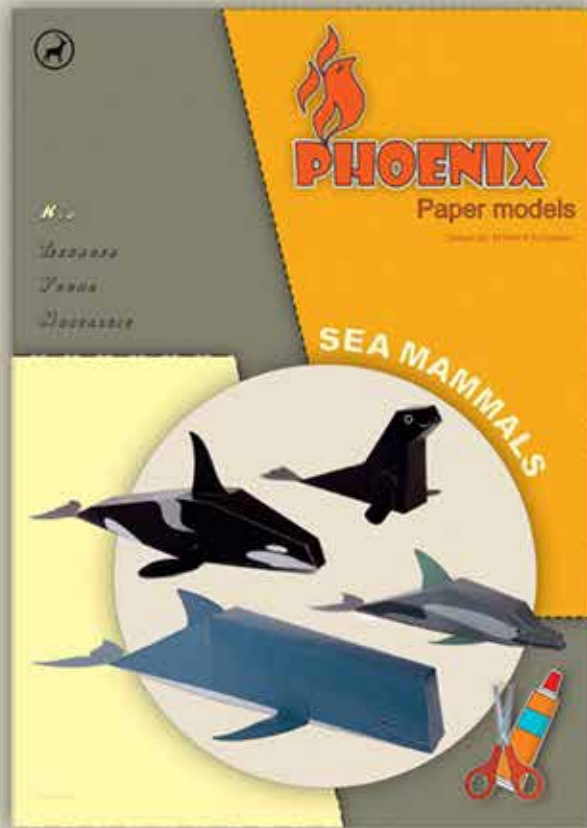

SEA LION :

In one A4 Size Pages

130 gr < Glossy paper < 200 gr

129.65.75mm



DOLPHIN :

In one A4 Size Pages

130gr < Glossy paper < 200 gr

166.43.70mm

TINY ANIMALS

PAPER MODEL

Sperm Whale

In one A4 Size Pages

130gr < Glossy paper < 200 gr

250.55.130mm

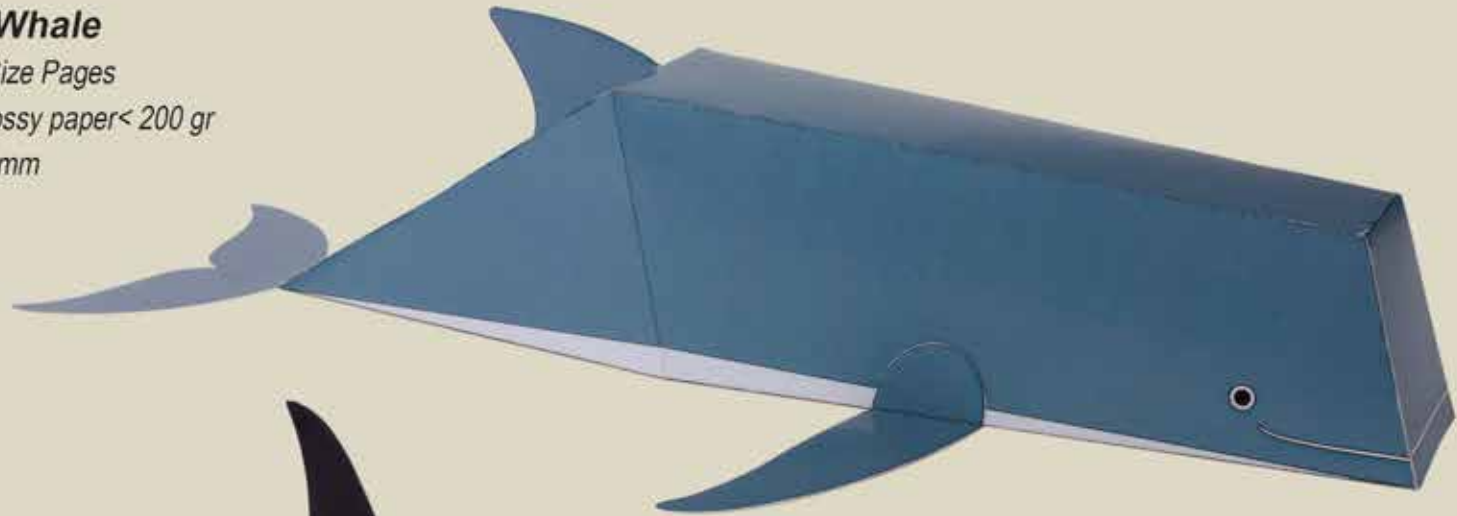

killer Whale (ORCA)

In one A4 Size Pages

130 gr < Glossy paper < 200 gr

250.125.67 mm

Completed models made by me

Iran Khodro

Iran Khodro Diesel Co.



Iran Khodro Diesel Company, The largest commercial vehicles manufacturer in the Middle East, has been a notable customer for me Since 2001. The managers order me the 3d paper model of their products for advertising purposes.

FOTON (Auman- EST/A)

Foton truck is the newest product of Iran khodro diesel company, intended to be manufactured by this company in cooperation with China. I designed and made Foton's 3d paper model under a contract with IKD-Co. for advertising purposes for the Tehran transportation exhibition in spring 2022.



Completed model made by me (In three A4 Size Pages 130gr Glossy paper)

HOWO TRUCK

PAPER MODEL / Summer 2009

Iran Khodro Diesel Co.

Howo Truck

This product was of considerable importance for the company's business strategies that resulted in being advertised in various ways such as promotional gifts particularly the 3D paper model as my other work.



Completed model made by me

In four A4 Size Pages

130gr < Glossy paper < 200 gr

205.90.110 mm

SC 457 BUS

PAPER MODEL / Spring 2008

SC 457 Bus

Designed and manufactured by the collaboration between Iran Khodro Diesel company and Neoplan (a German company), this bus was meeting serious competition in Iran`s market. Then powerful advertising seemed to be required that its 3D paper model shown on the photos, was the most popular.



Completed model made by me

In two A4 Size Pages

130gr < Glossy paper < 200 gr

268.62.86 mm

Iran Khodro Diesel Co.

Dump truck

Dump trucks as the main products of Iran Khodro Diesel co. can undoubtedly be said to be highly appropriate to be 3D paper models. I designed the model of Mighty truck manufactured by the mentioned company and the Korean one -Hyundai- to advertise it in Iran`s market.

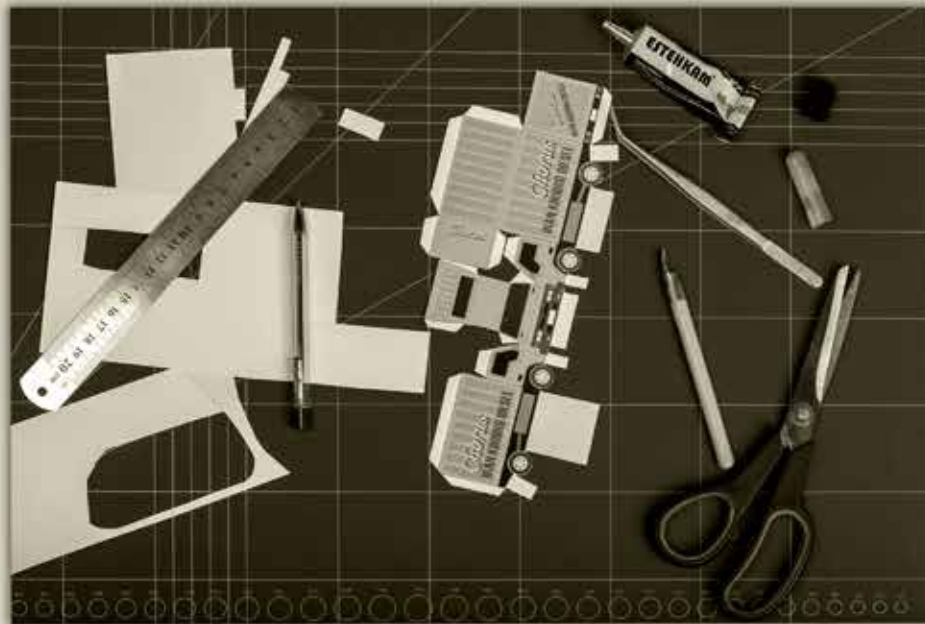

Printed and cut parts of the model ready to be pasted to each other.



MIGHTY (HYUNDAI)

PAPER MODEL / Spring 2007



Completed model made by me

In one A4 Size Page

130gr < Glossy paper < 200 gr

205.90.110 mm

Miscellaneous projects

In addition to my fulfilled projects presented, I've submitted several proposals to the companies and organizations whose products are appropriate for me to use as a 3D paper model. You can find their photos below.



3D paper models of MAN company's products / winter 2017



CARREIDAS 160(TIN TIN Adventures) / summer 2017



Chevy Blazer / winter 2016



TOYOTA Landcruiser / summer 2017

MAN TRUCK

PAPER MODEL



Completed model made by me

In four A4 Size Pages

80 gr < Glossy paper < 200 gr

190.86.128mm



MAN TGA 18.350 LX Tractorhead

CARREIDAS 160(Jet)

PAPER MODEL

Miscellaneous projects

The 3D paper model of Carreidas 160, in Tin Tin comic strip book, by Hergé that is published in Iran by Ghadyani publishing.

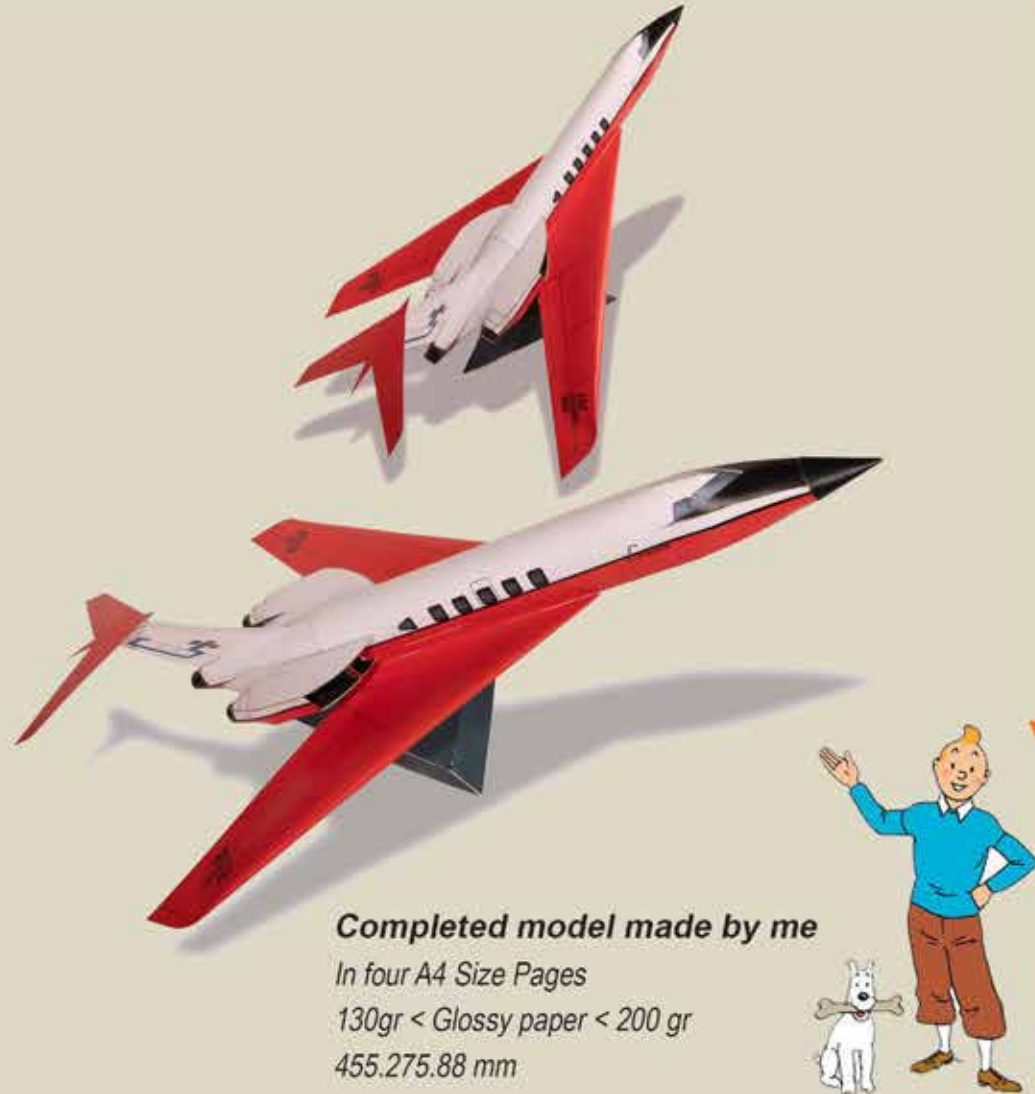

Completed model made by me

In four A4 Size Pages

130gr < Glossy paper < 200 gr

455.275.88 mm

CHEVY K5 Blazer

PAPER MODEL

The 3D paper model proposed to the Ministry of Education intended for students to take a course in model making run by me, for free.



*In two A4 Size Pages
130 gr < Glossy paper < 200 gr
150.63.64 mm*

TOYOTA JEEP

PAPER MODEL

3D paper model of Toyota's ambulance proposed to Iran and Iraq War Museum in Tehran.



*In two A4 Size Pages
130 gr < Glossy paper < 200 gr
162.65.58 mm*

Completed models made by me



Part IV (Exhibitions, Certificates, . . .)

Exhibitions

Certificates

Memberships

Interviews

The Letters of Appreciation

Exhibitions

Exhibitions

Since 2007, I have held solo and group exhibitions that you can find some information about the most remarkable ones.

"MY PAPER WORLD" EXHIBITION, Held at Blue Art Gallery in Omid Cultural Centre.



Unesco's members accompanied by Omid Cultural Center executive visiting my exhibition (My Paper World), held in Autumn 2018

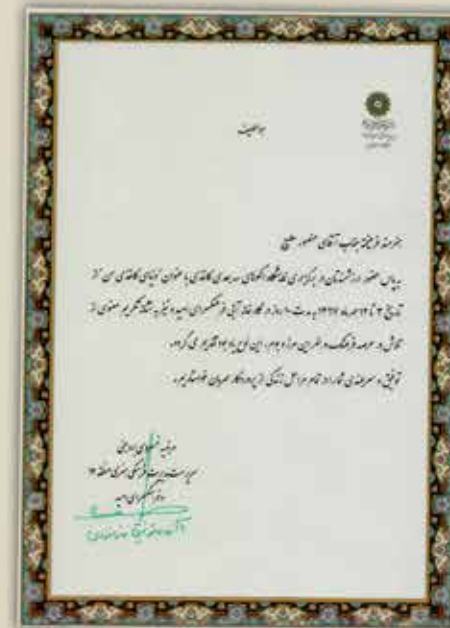

The letter of appreciation I received on behalf of Omid Cultural Center

Exhibitions

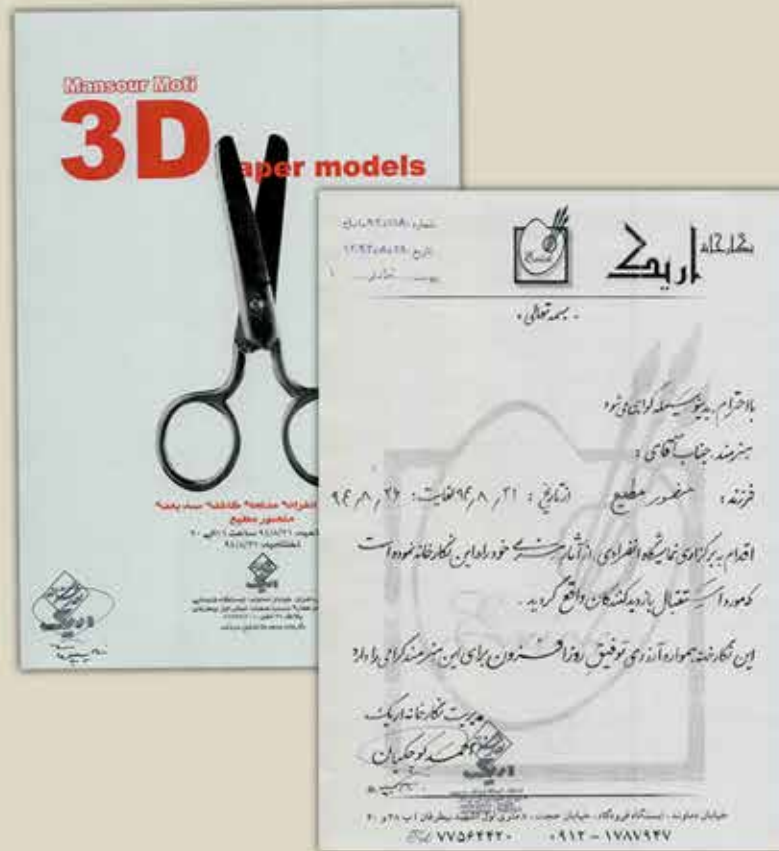

SOLO "3D PAPER MODELS" EXHIBITION, TEHRAN, IRAN
Held at Erick Art Gallery, 11.2015



SOLO GRAPHIC ART DESIGN EXHIBITION, TEHRAN, IRAN
Held at Erick Art Gallery, 06.2016

Certificates



PRINCIPLES AND TECHNIQUES OF THE SUCCESSFUL NEGOTIATIONS TRAINING COURSE, 02.2012



EFFECTIVE COMMUNICATION SKILLS TRAINING COURSE, 10.2012

Logotype Of Namasaaz Magazine



ماگازین و مجله تخصصی کارآفرینی، کسب و کار، بازاریابی و مدیریت در ایران

License to publish " Namasaaz " Monthly Magazine on September 2015.

This magazine is in the field of handicrafts and traditional arts training specialized in the 3D paper models in Persian and English Language. Based on some business strategies related to the Iran`s market, "Namasaaz" has not been published yet.



Certificates



"ADOBE PHOTOSHOP"
TRAINING COURSE, 09.2009 – 07.2009



MACROMEDIA FLASH MX (ADVANTAGE AND PRELIMINARY)
TRAINING COURSE, 02.2006 – 01.2006



"COREL DRAW AND COREL-PHOTO PAINT"
TRAINING COURSE, 04.2004



"3D STUDIO MAX I"
TRAINING COURSE, 05.2003

Memberships



INSTITUTE FOR PROMOTION OF CONTEMPORARY VISUAL ART, IN THE FIELD OF GRAPHICS, TEHRAN, IRAN, 06.2018 - Present



TEHRAN MUSEUM OF CONTEMPORARY ART Library, TEHRAN, IRAN 07.2018 - Present

Memberships



IRANIAN ASSOCIATION OF WRITERS FOR CHILDREN
& YOUTH- TEHRAN/IRAN
12.2021 – Present



SPECIAL CREDIT CARD FOR ARTISTS WHO ARE MEMBERS
OF THE ART CREDIT FUND.
06.2018 - Present



IRANIAN SCIENTIFIC ASSOCIATION OF VISUAL ART,
TEHRAN, IRAN
02.2018 – Present



INTERVIEWS

NASL-E-BARTAR MAGAZINE & OFOQ-E-EMROOZ NEWSLETTER



My interview printed in "Ofoq-E-Emrooz" Quarterly Newsletter of Ofoq publishing No.7, Summer 2005.



My interview printed in "Nasl-E-Bartar" Monthly Magazine specialized in Automobile No. 77, August 2013.

The news of the publication of 5 volumes 3D paper models books namely, " Road Construction Vehicles" from my collection books under the title of " Kardastye Man" was printed in Hamshahri Newspaper No.7452 on August 9th,2018. (newspaper.hamshahri.org).



“IRAN KHODRO DIESEL”
INDUSTRIAL GROUP
letter of Appreciation



ARTISTIC AND CULTURAL
INSTITUTE OF “KELK 80”
letter of Appreciation

Contact info

- Unit 4, No. 10, Shahid Abbas Shayegan All., Baradaran Baba Khanloo St., Khaje Nezamolmolck St., Tehran, Iran
- (+98)9124409432 / (+98)9038668444
- LinkedIn: Mansour-moti
- www.pinterest.com/mansourmoti/
- [mansourmoti@instagram](https://www.instagram.com/mansourmoti)
- www.mansourmoti.com
- mansour.moti@gmail.com, Info@mansourmoti.com



PORTFOLIO
MANSOUR
MOTI
Designer Of 3D Paper Models
& Graphic Designer